

SMD LED LAMP, Bi-Color Type

BL-LS1615B0E2

Features:

- 1.6mmx1.5mm SMD, 0.75mm THICKNESS
- Bi-color type
- Compatible with automatic placement equipment
- WIDE VIEWING ANGLE.
- IDEAL FOR BACKLIGHT AND INDICATOR.
- PACKAGE: 4KPCS/REEL
- RoHs Compliance



■ Electrical-optical characteristics: (Ta=25°C) (Test Condition: IF=20mA)

Part Number	Chip			Lens Type	Forward Voltage(VF) Unit:V		Luminous Intensity (lv) Unit:mcd		Viewing Angle 2θ1/2 (deg)
	Emitted Color	Material	λ _p (nm)		Typ	Max	Min.	Typ.	
					BL-LS1615B0E2EGC	Red	GaAsP	635	
	Green	GaP	568	2.30	2.70	6	15		
BL-LS1615B0E2UYUGC	Ultra Yellow	AllnGaP	593	2.10	2.60	30	65		
	Ultra Green	AllnGaP	575	2.20	2.70	40	80		
BL-LS1615B0E2UEUGC	Ultra Red	AllnGaP	630	2.10	2.60	30	70		
	Ultra Green	AllnGaP	575	2.20	2.70	40	80		

■ Absolute maximum ratings (Ta=25°C)

Parameter	Rating	Unit
Forward Current I _F	30	mA
Power Dissipation P _d	78	mW
Reverse Voltage V _R	5	V
Peak Forward Current I _{PF} (Duty 1/10 @1KHZ)	100	mA
Operation Temperature T _{OPR}	-30 to +80	°C
Storage Temperature T _{STG}	-40 to +85	°C
Lead Soldering Temperature T _{SOL}	Max.260±5°C for 3 sec Max. (1.6mm from the base of the epoxy bulb)	°C

SMD LED LAMP, Bi-Color Type

BL-LS1615B0E2

■ **Package configuration & Internal circuit diagram**

BL-LS1615B0E2 Series

Package Outline Drawing

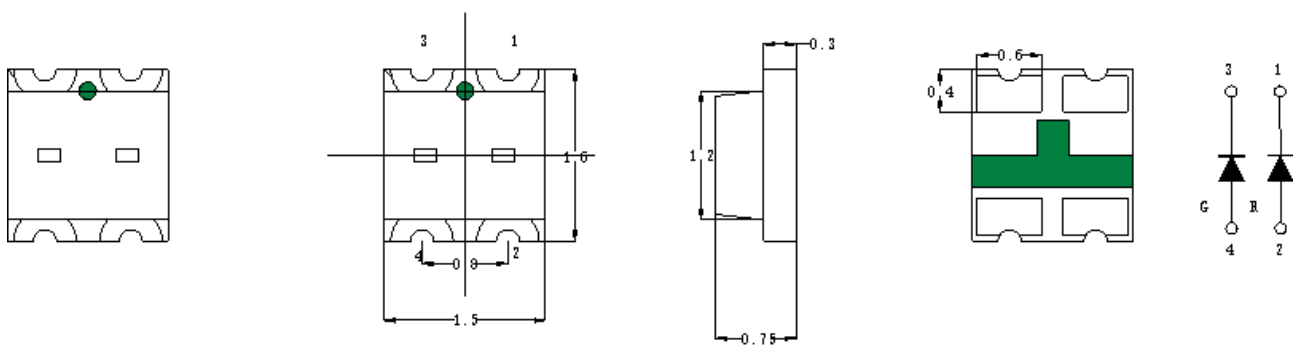

Recommended Soldering Pad Dimensions

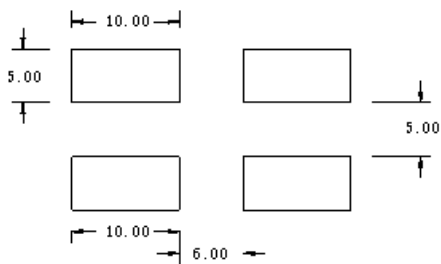

Notes:

1. All dimensions are in millimeters (inches)
2. Tolerance is $\pm 0.25(0.01)$ unless otherwise noted.
3. Specifications are subject to change without notice.

SMD LED LAMP, Bi-Color Type

BL-LS1615B0E2

■ **Tape Specifications**

Smt Reflow Soldering Instructions

Number of reflow process shall be less than 2 times and cooling process to normal temperature is required between first and second soldering process

■ **Lead-free Solder**

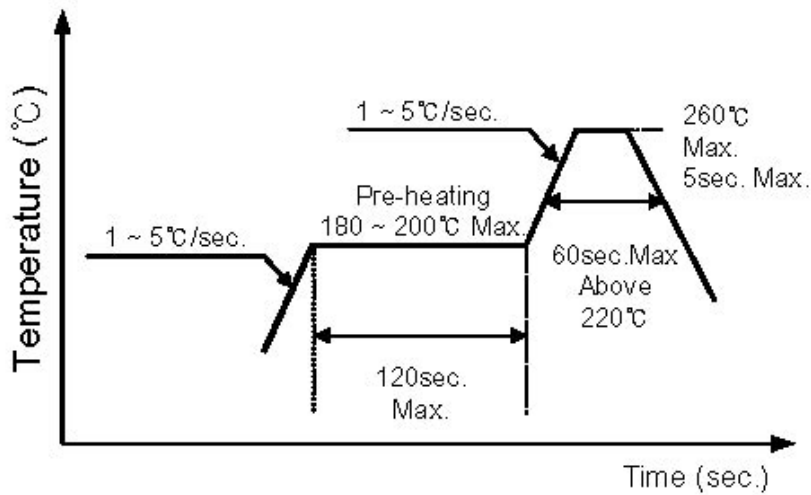

■ **Tape Specifications**

(Units:mm)

Tape Specifications

Unit:mm

Tolerance:±0.1

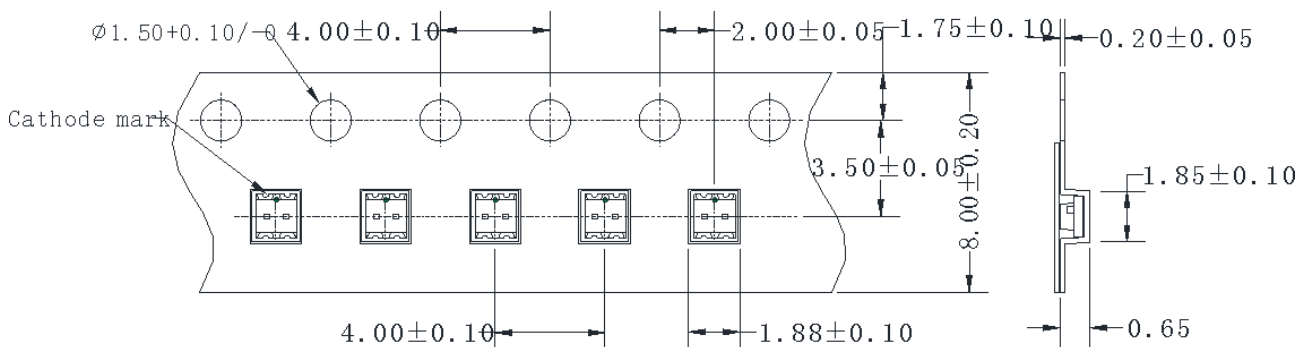

SMD LED LAMP, Bi-Color Type

BL-LS1615B0E2

■ **Typical electrical-optical characteristics curves:**

Red

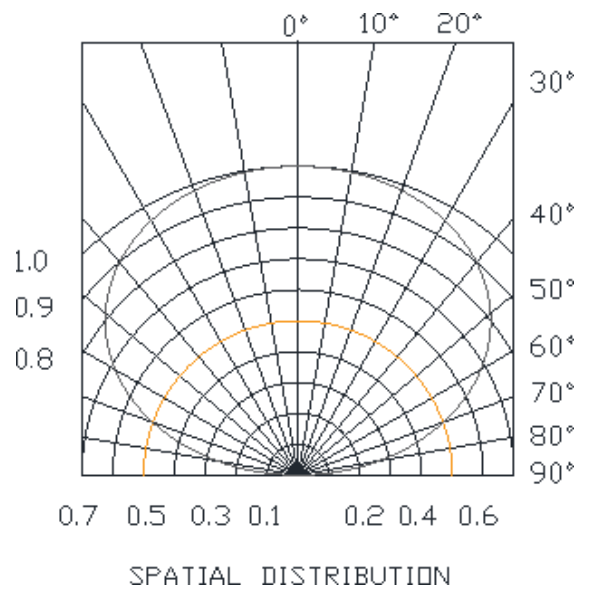
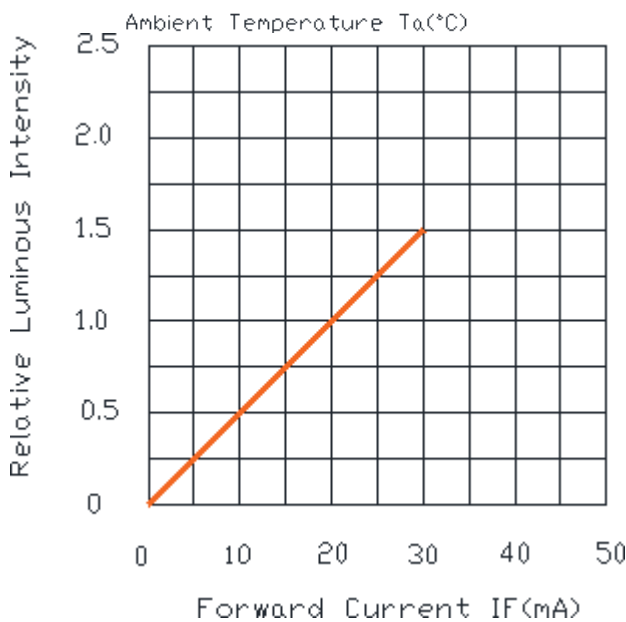
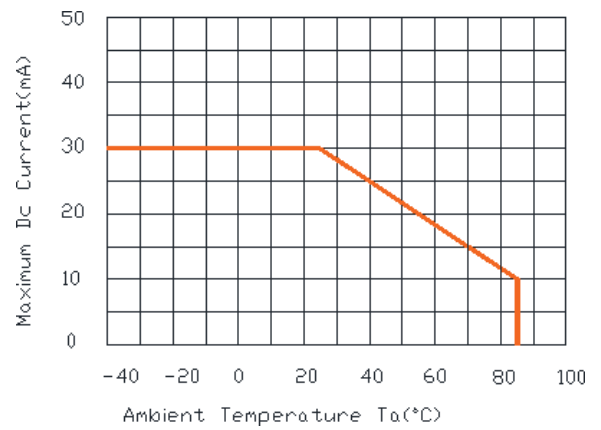
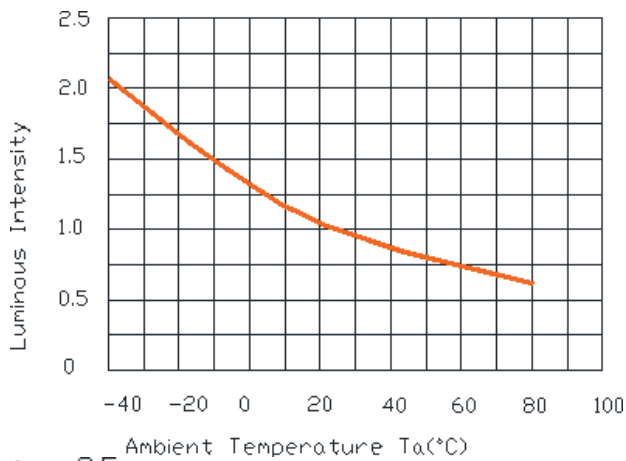
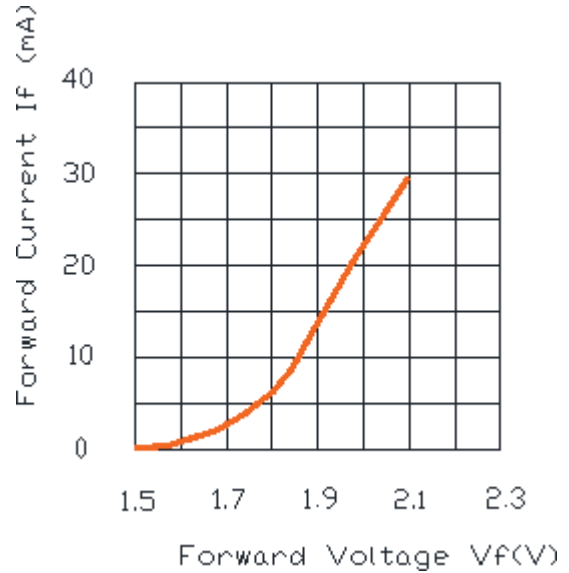
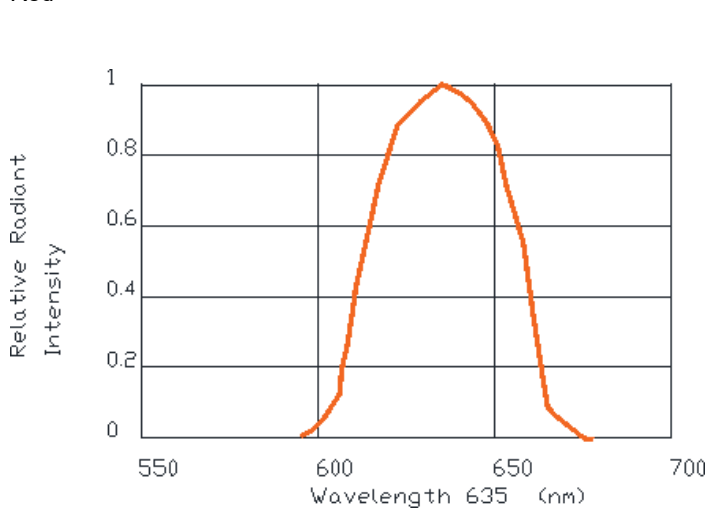

SMD LED LAMP, Bi-Color Type

BL-LS1615B0E2

Green

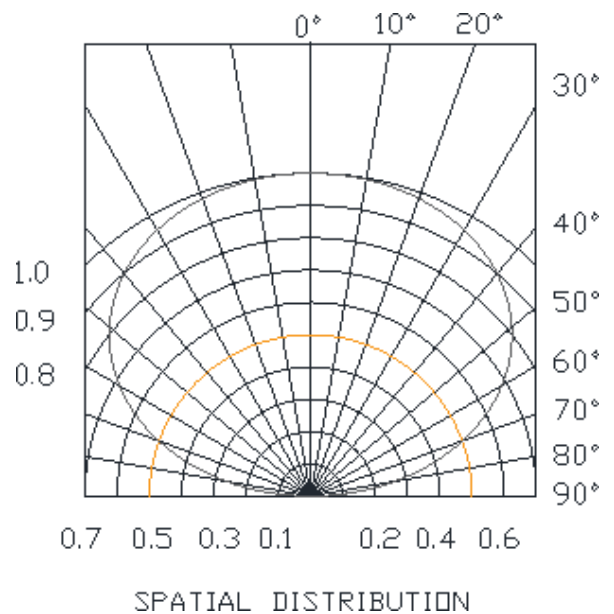
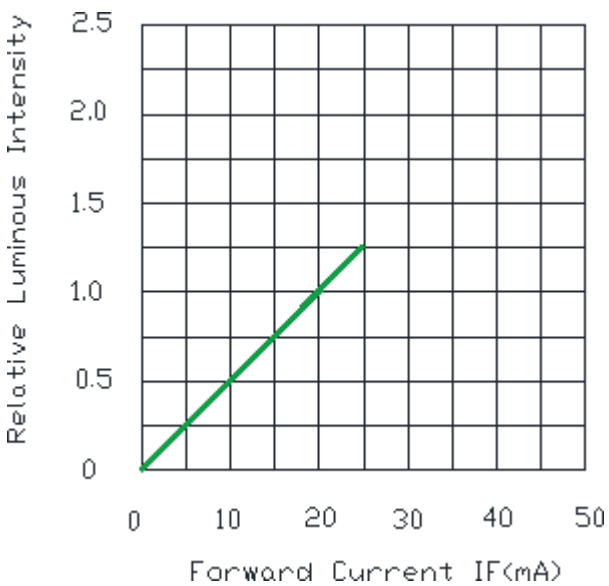
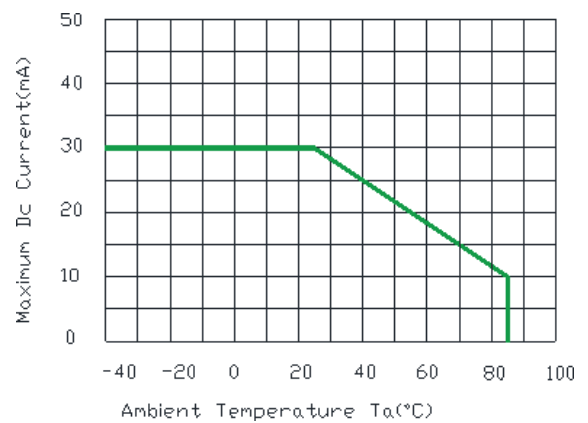
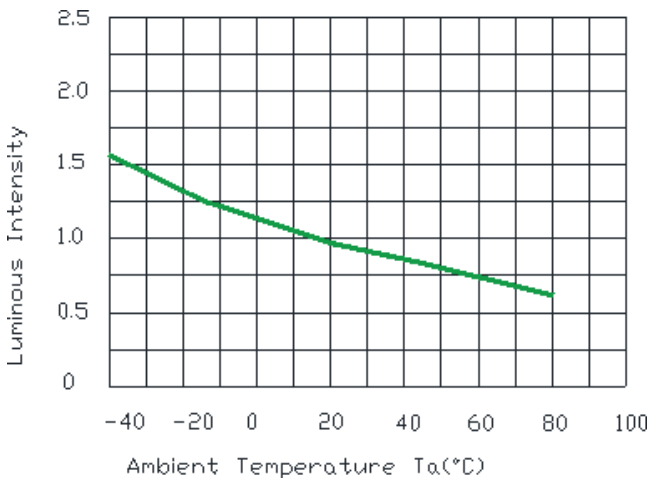
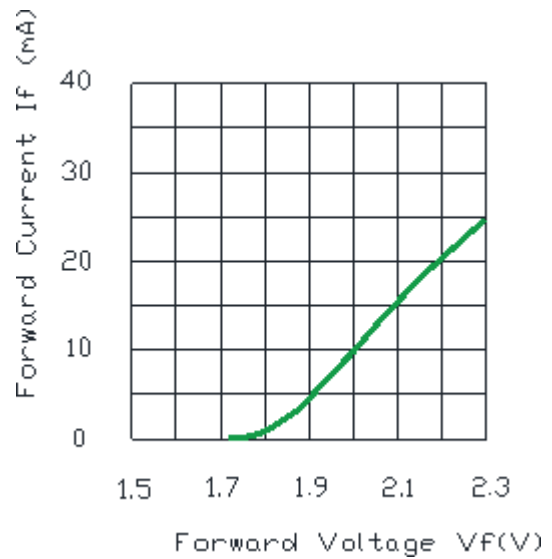
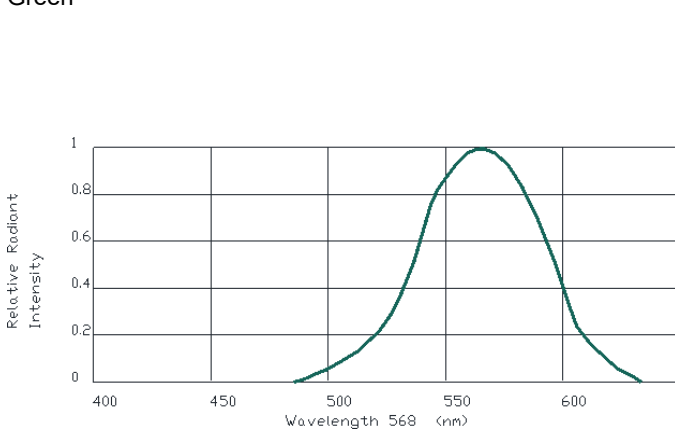

SMD LED LAMP, Bi-Color Type

BL-LS1615B0E2

Ultra Yellow

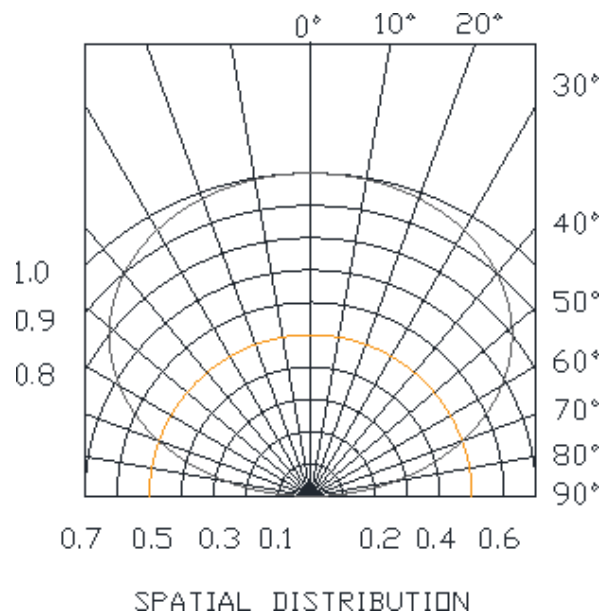
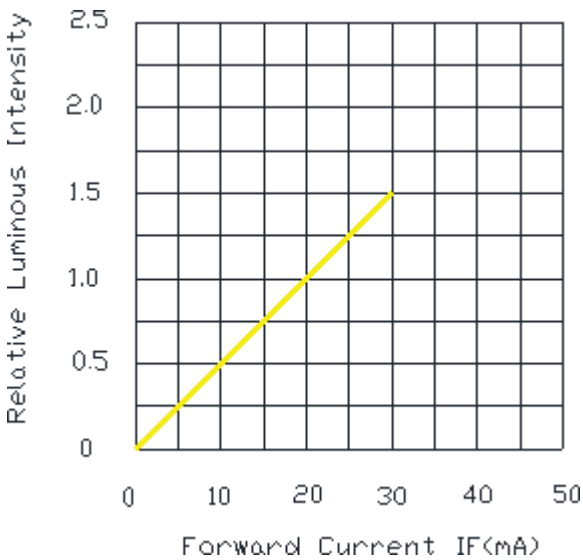
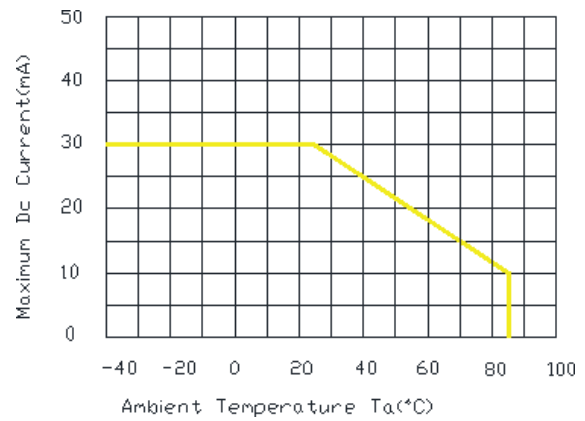
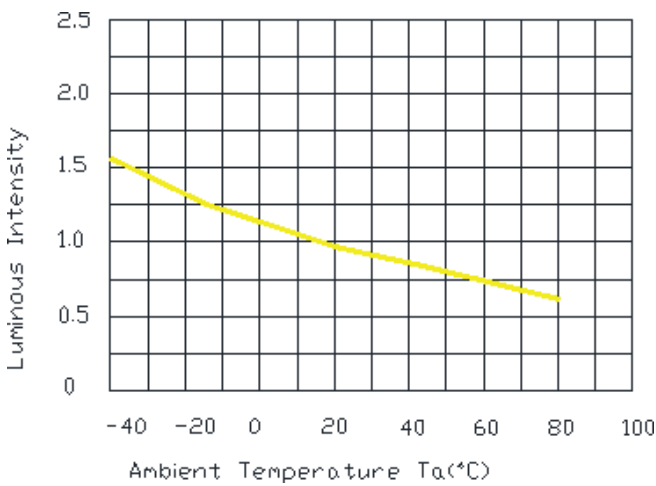
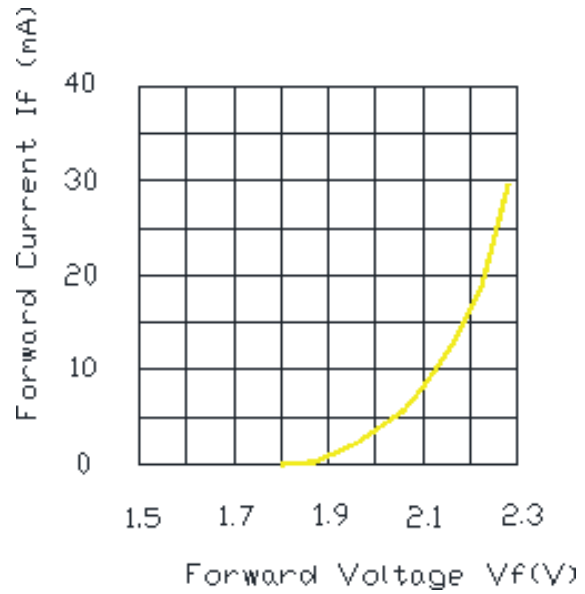
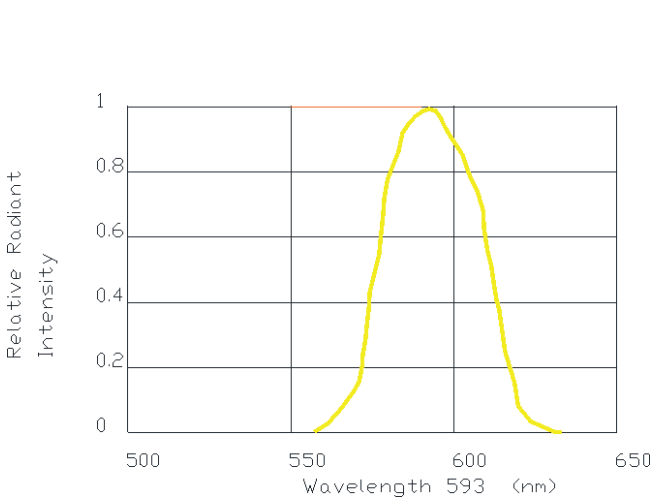

SMD LED LAMP, Bi-Color Type

BL-LS1615B0E2

Ultra Green

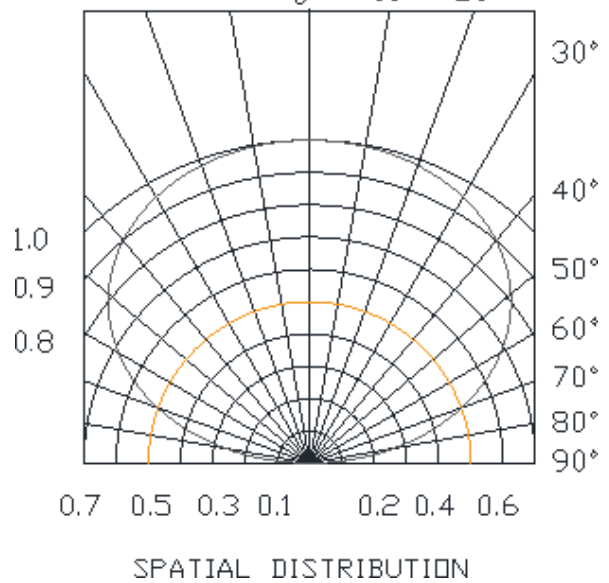
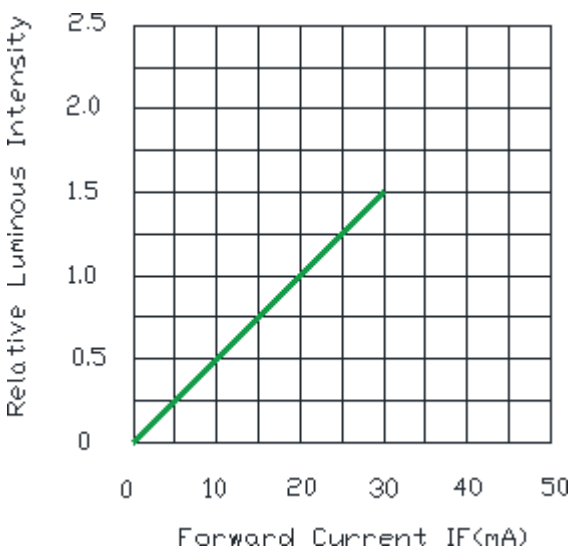
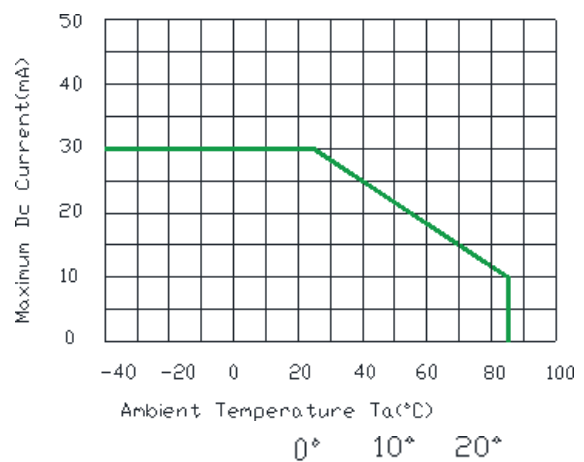
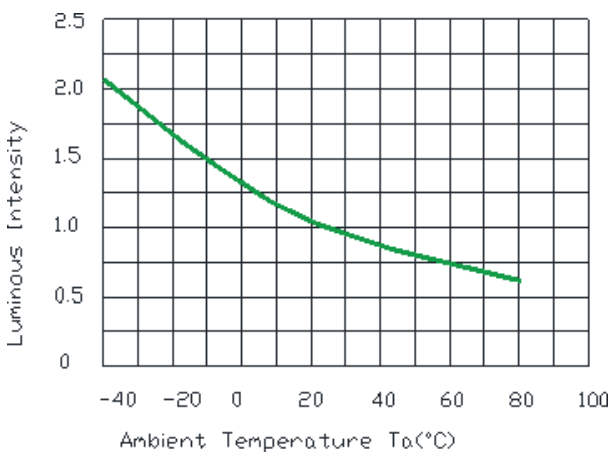
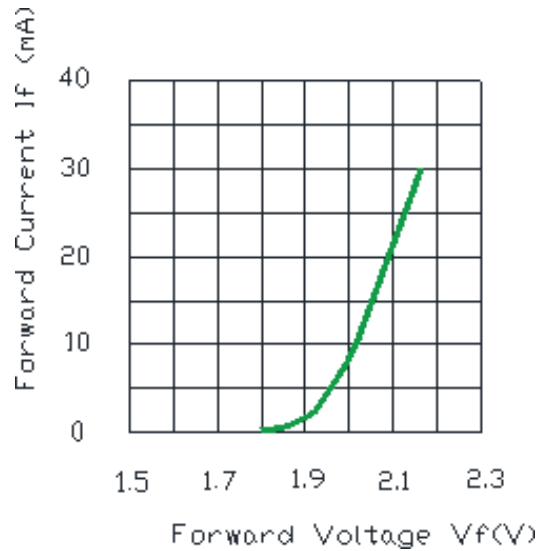
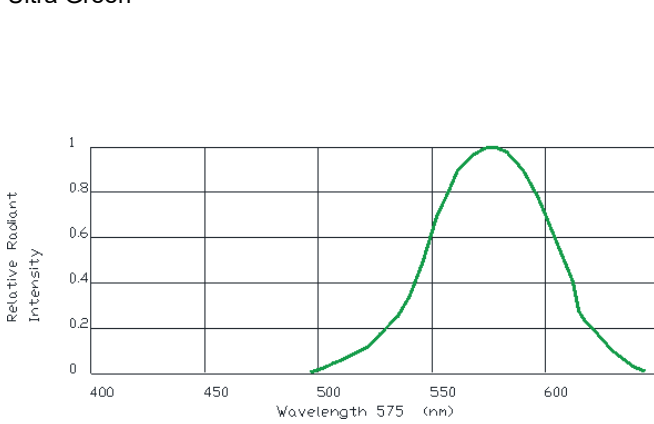

SMD LED LAMP, Bi-Color Type

BL-LS1615B0E2

Ultra Red

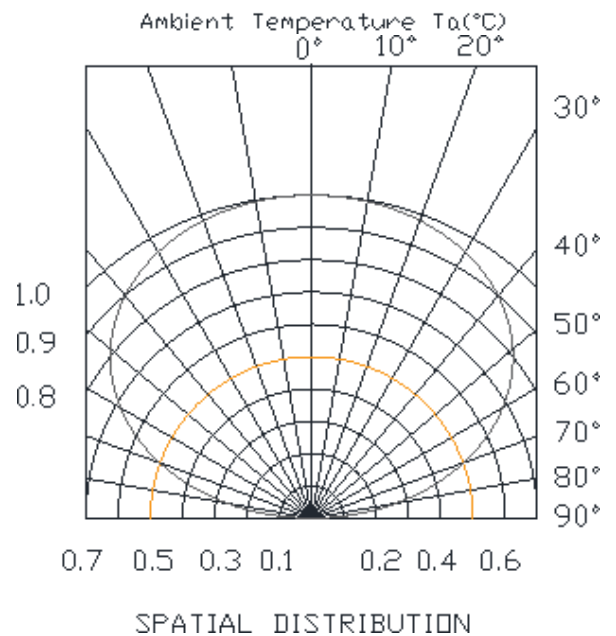
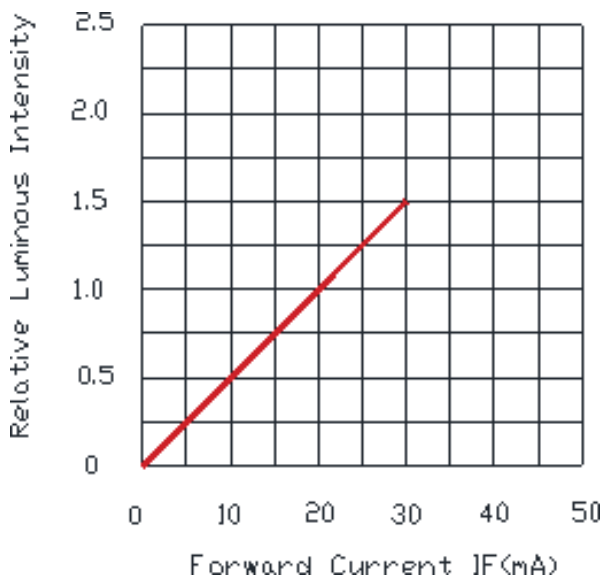
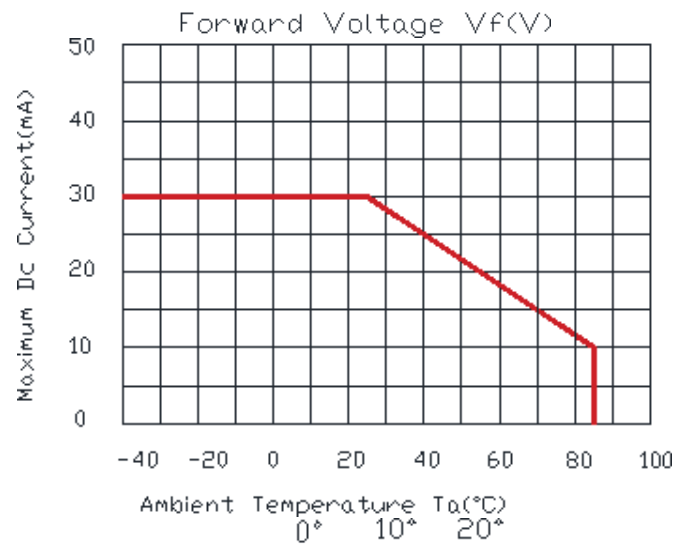
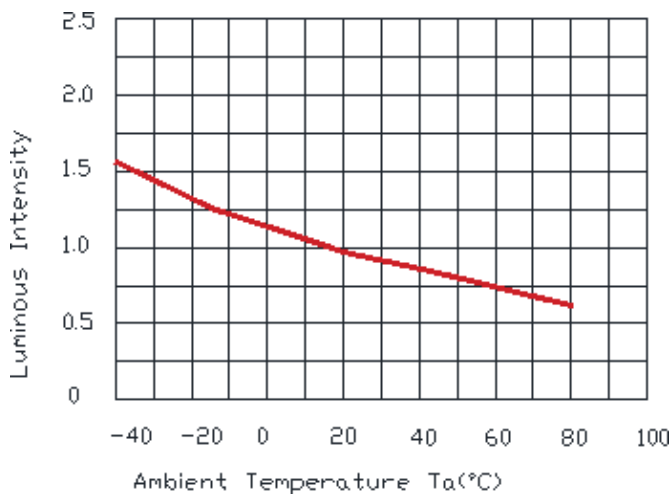
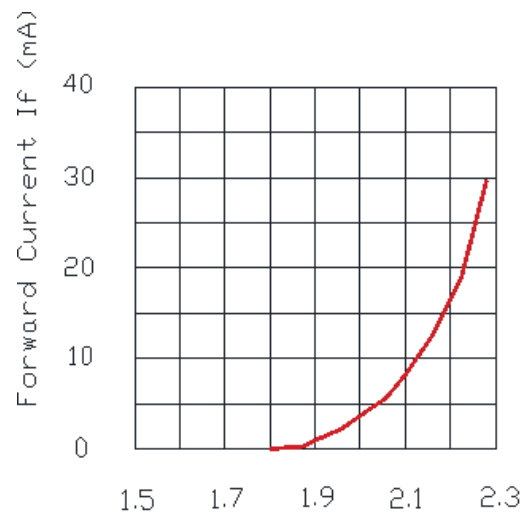
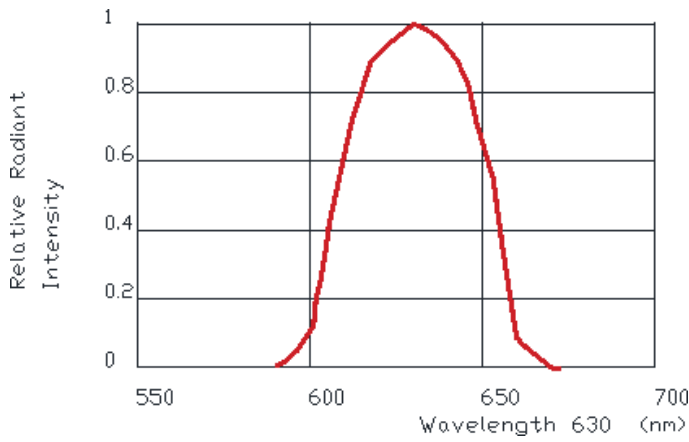

SMD LED LAMP, Bi-Color Type

BL-LS1615B0E2

■ **Packing and weighting**

