

SMD LED LAMP
BL-LS2724A0S3xxx
Features:

- 2.7*2.4mm SMD, PLCC4 package
- RGB type, Ultra brightness
- Compatible with automatic placement equipment
- WIDE VIEWING ANGLE.
- IDEAL FOR BACKLIGHT AND INDICATOR.
- PACKAGE: 2KPCS/REEL
- RoHs Compliance

■ Electrical-optical characteristics: (Ta=25°C) (Test Condition: IF=20mA)

Part Number	Chip			Lens Type	Forward Voltage(VF) Unit:V		Luminous Intensity (lv) Unit:mcd		Viewing Angle 2θ1/2 (deg)
	Emitted Color	Material	λ _p (nm)		Typ	Max	Min.	Typ.	
					BL-LS2724A0S3 URUGUBC	Ultra Red	AlGaInP	630	
	Ultra Pure Green	InGaN	525		3.10	4.20	1300	1500	
	Ultra Blue	InGaN	470		3.10	4.20	450	500	

■ Absolute maximum ratings (Ta=25°C)

Parameter	UR	UG	UB					Unit
Forward Current I _F	30	30	30					mA
Power Dissipation P _d	78	78	78					mW
Reverse Voltage V _R	5	5	5					V
Peak Forward Current I _{PF} (Duty 1/10 @1KHZ)	100	100	100					mA
Operation Temperature T _{OPR}	-30 to +80							°C
Storage Temperature T _{STG}	-40 to +85							°C
Lead Soldering Temperature T _{SOL}	Max.260±5°C for 3 sec Max. (1.6mm from the base of the epoxy bulb)							°C

SMD LED LAMP

BL-LS2724A0S3xxx

■ Package configuration & Internal circuit diagram

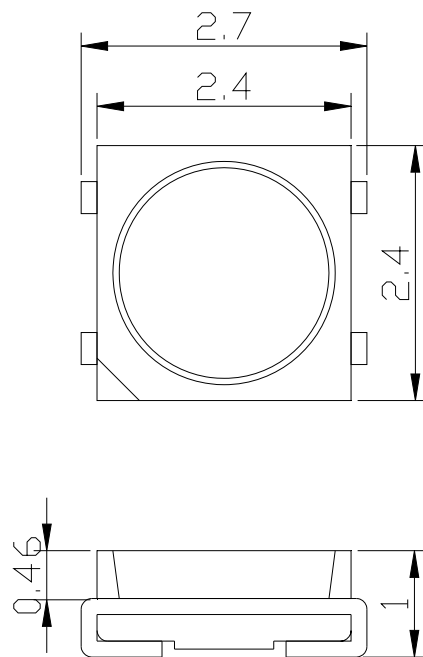

Notes:

1. All dimensions are in millimeters (inches)
2. Tolerance is $\pm 0.25(0.01)$ unless otherwise noted.
3. Specifications are subject to change without notice.

SMD LED LAMP

BL-LS2724A0S3xxx

Typical electrical-optical characteristics curves:

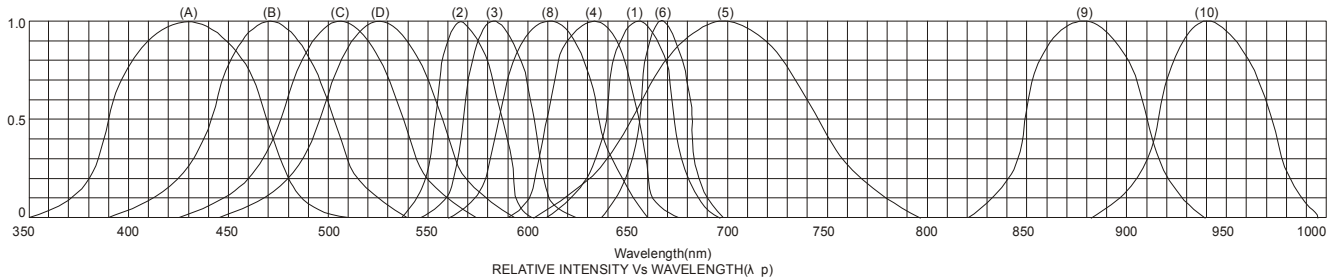

- (1) - GaAsP/GaAs 655nm/Red
- (2) - GaP 570nm/Yellow Green
- (3) - GaAsP/GaP 585nm/Yellow
- (4) - GaAsP/GaP 635nm/Orange & Hi-Eff Red
- (5) - GaP 700nm/Bright Red
- (6) - GaAlAs/GaAs 660nm/Super Red
- (8) - GaAsP/GaP 610nm/Super Red
- (9) - GaAlAs 880nm
- (10) - GaAs/GaAs & GaAlAs/GaAs 940nm
- (A) - GaN/SiC 430nm/Blue
- (B) - InGaN/SiC 470nm/Blue
- (C) - InGaN/SiC 505nm/Ultra Green
- (D) - InGaAl/SiC 525nm/Ultra Green

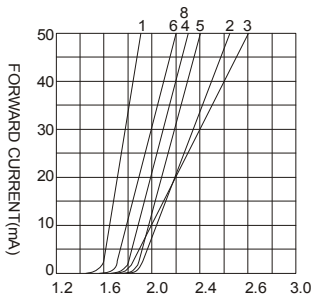

FORWARD VOLTAGE (Vf)
FORWARD CURRENT VS.
FORWARD VOLTAGE

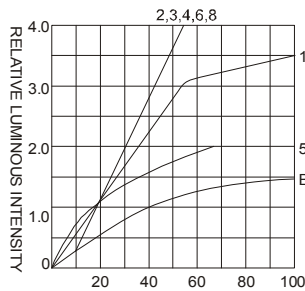

FORWARD CURRENT (mA)
RELATIVE LUMINOUS
INTENSITY VS. FORWARD
CURRENT

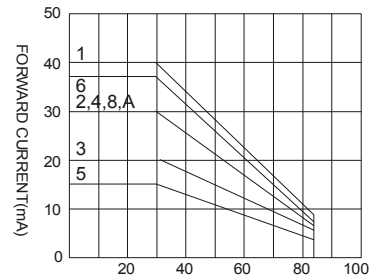

AMBIENT TEMPERATURE Ta(°C)
FORWARD CURRENT VS. AMBIENT
TEMPERATURE

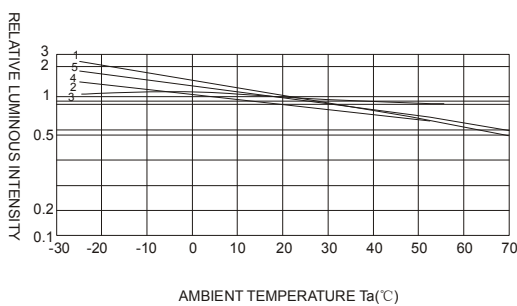

AMBIENT TEMPERATURE Ta(°C)

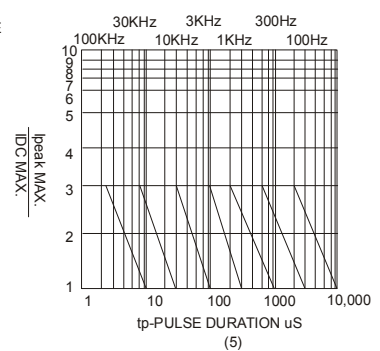
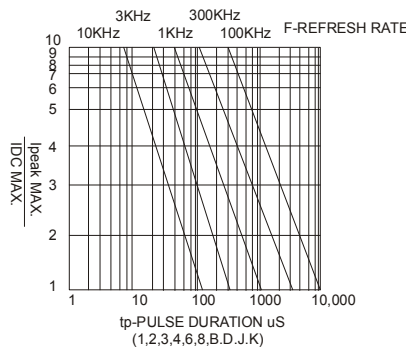

NOTE:25°C free air temperature unless otherwise specified

SMD LED LAMP

BL-LS2724A0S3xxx

■ **Packing and weighting**

