

## LED NUMERIC DISPLAY, 4 DIGIT

BL-Q30X-61

### Features:

- 7.68mm (0.3") 6 digit numeric display series.
- Low current operation.
- Excellent character appearance.
- Easy mounting on P.C. Boards or sockets.
- I.C. Compatible.
- ROHS Compliance.



### Super Bright

**Electrical-optical characteristics: (Ta=25°C)** (Test Condition: IF=20mA)

Part No		Chip			VF Unit:V		Iv TYP.(mcd)
Common Cathode	Common Anode	Emitted Color	Material	$\lambda_p$ (nm)	Typ	Max	
BL-Q30A-61S-XX	BL-Q30B-61S-XX	Hi Red	GaAlAs/GaAs,SH	660	1.85	2.20	100
BL-Q30A-61D-XX	BL-Q30B-61D-XX	Super Red	GaAlAs/GaAs,DH	660	1.85	2.20	110
BL-Q30A-61UR-XX	BL-Q30B-61UR-XX	Ultra Red	GaAlAs/GaAs,DDH	660	1.85	2.20	150
BL-Q30A-61E-XX	BL-Q30B-61E-XX	Red	GaAsP/GaP	635	2.10	2.50	105
BL-Q30A-61Y-XX	BL-Q30B-61Y-XX	Yellow	GaAsP/GaP	585	2.10	2.50	105
BL-Q30A-61G-XX	BL-Q30B-61G-XX	Green	GaP/GaP	570	2.20	2.50	110

### Ultra Bright

**Electrical-optical characteristics: (Ta=25°C)** (Test Condition: IF=20mA)

Part No		Chip			VF Unit:V		Iv TYP.(mcd)
Common Cathode	Common Anode	Emitted Color	Material	$\lambda_p$ (nm)	Typ	Max	
BL-Q30A-61UHR-XX	BL-Q30B-61UHR-XX	Ultra Red	AlGaInP	645	2.10	2.50	150
BL-Q30A-61UE-XX	BL-Q30B-61UE-XX	Ultra Red	AlGaInP	630	2.10	2.50	130
BL-Q30A-61YO-XX	BL-Q30B-61YO-XX	Ultra Amber	AlGaInP	619	2.10	2.50	130
BL-Q30A-61UY-XX	BL-Q30B-61UY-XX	Ultra Yellow	AlGaInP	590	2.10	2.50	120
BL-Q30A-61UG-XX	BL-Q30B-61UG-XX	Ultra Green	AlGaInP	574	2.20	2.50	130
BL-Q30A-61PG-XX	BL-Q30B-61PG-XX	Ultra Pure Green	InGaIn	525	3.80	4.50	195
BL-Q30A-61B-XX	BL-Q30B-61B-XX	Ultra Blue	InGaIn	470	2.70	4.20	120
BL-Q30A-61W-XX	BL-Q30B-61W-XX	Ultra White	InGaIn	/	2.70	4.20	140

■ -XX: Surface / Lens color:

Number	0	1	2	3	4	5
Ref Surface Color	White	Black	Gray	Red	Green	
Epoxy Color	Water clear	White diffused	Red Diffused	Green Diffused	Yellow Diffused	

**LED NUMERIC DISPLAY, 4 DIGIT**
**BL-Q30X-61**
**Absolute maximum ratings (Ta=25°C)**

Parameter	S	D	UR	E	Y	G	Unit
Forward Current $I_F$	25	25	25	25	25	30	mA
Power Dissipation $P_d$	60	60	60	60	60	65	mW
Reverse Voltage $V_R$	5	5	5	5	5	5	V
Peak Forward Current $I_{PF}$ (Duty 1/10 @1KHZ)	150	150	150	150	150	150	mA
Operation Temperature $T_{OPR}$	-40 to +80						°C
Storage Temperature $T_{STG}$	-40 to +85						°C
Lead Soldering Temperature $T_{SOL}$	Max.260±5°C for 3 sec Max. (1.6mm from the base of the epoxy bulb)						°C

**■ Absolute maximum ratings (Ta=25°C)**

Parameter	UHR	UE	YO	UY	UG	PG	UB	UW	Unit
Forward Current $I_F$	30	30	30	30	30	30	30	30	mA
Power Dissipation $P_d$	75	65	65	65	75	110	120	120	mW
Reverse Voltage $V_R$	5	5	5	5	5	5	5	5	V
Peak Forward Current $I_{PF}$ (Duty 1/10 @1KHZ)	150	150	150	150	150	150	100	100	mA
Operation Temperature $T_{OPR}$	-40 to +80								°C
Storage Temperature $T_{STG}$	-40 to +85								°C
Lead Soldering Temperature $T_{SOL}$	Max.260±5°C for 3 sec Max. (1.6mm from the base of the epoxy bulb)								°C

**LED NUMERIC DISPLAY, 4 DIGIT**

**BL-Q30X-61**

■ **Package configuration & Internal circuit diagram**

**BL-Q30X-61 Series**

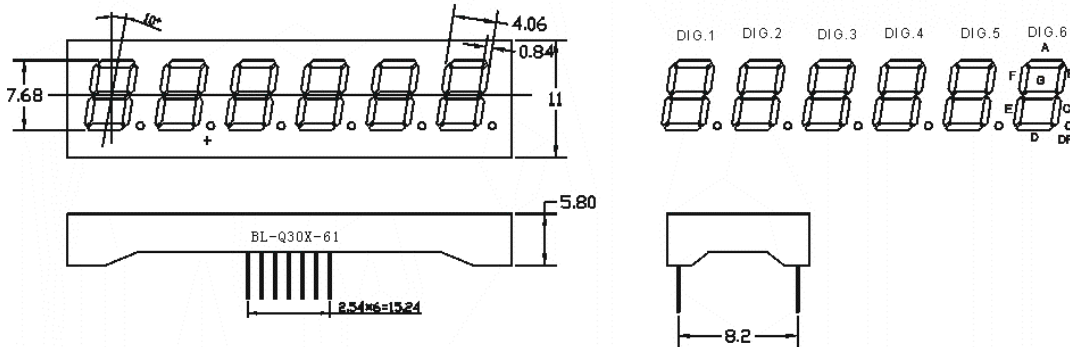

**BL-Q30A-61**

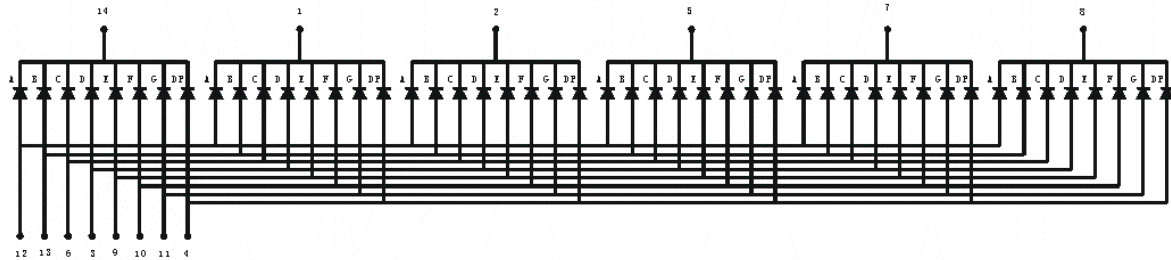

**BL-Q30B-61**

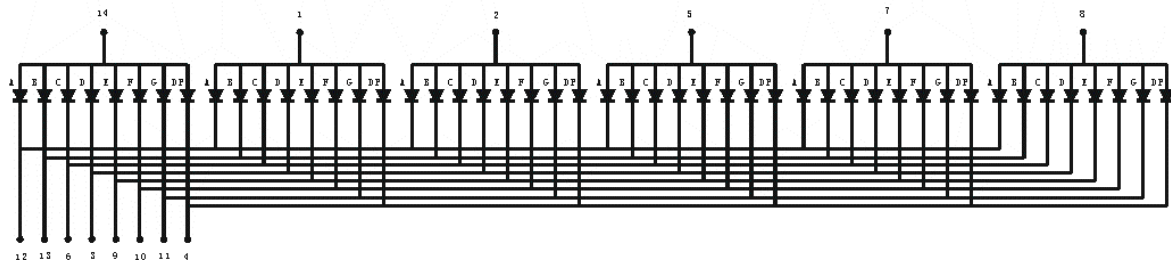

**Notes:**

1. All dimensions are in millimeters (inches)
2. Tolerance is  $\pm 0.25(0.01)$  unless otherwise noted.
3. Specifications are subject to change without notice.

# LED NUMERIC DISPLAY, 4 DIGIT

**BL-Q30X-61**

## Typical electrical-optical characteristics curves:



- (1) - GaAsP/GaAs 655nm/Red
- (2) - GaP 570nm/Yellow Green
- (3) - GaAsP/GaP 585nm/Yellow
- (4) - GaAsP/GaP 635nm/Orange & Hi-Eff Red
- (5) - GaP 700nm/Bright Red
- (6) - GaAlAs/GaAs 660nm/Super Red
- (8) - GaAsP/GaP 610nm/Super Red
- (9) - GaAlAs 880nm
- (10) - GaAs/GaAs & GaAlAs/GaAs 940nm
- (A) - GaN/SiC 430nm/Blue
- (B) - InGaN/SiC 470nm/Blue
- (C) - InGaN/SiC 505nm/Ultra Green
- (D) - InGaAl/SiC 525nm/Ultra Green

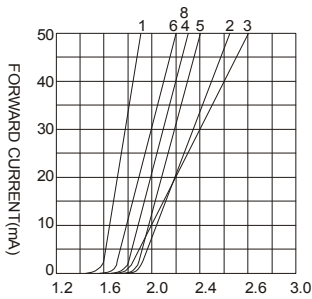

FORWARD VOLTAGE (Vf)  
FORWARD CURRENT VS.  
FORWARD VOLTAGE



FORWARD CURRENT (mA)  
RELATIVE LUMINOUS  
INTENSITY VS. FORWARD  
CURRENT



AMBIENT TEMPERATURE Ta(°C)  
FORWARD CURRENT VS. AMBIENT  
TEMPERATURE

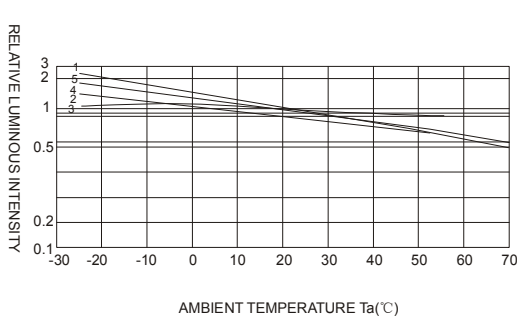

AMBIENT TEMPERATURE Ta(°C)

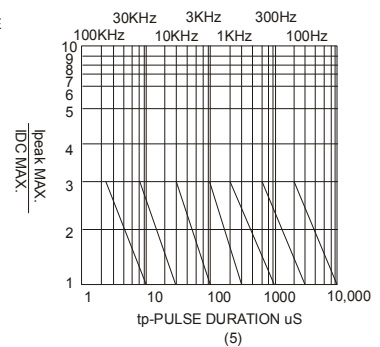
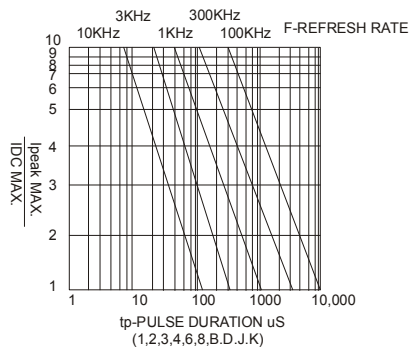

NOTE:25°C free air temperature unless otherwise specified

**LED NUMERIC DISPLAY, 4 DIGIT**

**BL-Q30X-61**

■ Packing and weighting

