

Cylindrical , bi-color LED lamp

BL-L345

Features:

- Ø 3.0mm Cylindrical, Bi-color LED lamp
- Ø Ultra brightness.
- Ø Choice of various viewing angles.
- Ø Diffused, Transparent and Water clear lens are available.
- Ø IC compatible /Low current capability.
- Ø RoHs Compliance



Electrical-optical characteristics: (Ta=25°C) (Test Condition: IF=20mA)

Part Number	Chip			Lens Type	Forward Voltage(VF) Unit:V		Luminous Intensity (Iv) Unit:mcd		Viewing Angle 2θ/2(deg)
	Emitted Color	Material	λp 5 (nm)		Typ	Max	Min.	Typ	
BL-L345EGW	Orange	GaAsP/GaP	635	Water Diff.	2.10	2.50	5	15	100
	Green	GaP/GaP	570		2.20	2.50	3	10	
BL-L345YGW	Yellow	GaAsP/GaP	585		2.10	2.50	3	10	
	Green	GaP/GaP	570		2.20	2.50	3	10	
BL-L345UEUGW	Ultra Yellow	AlGaInP	630		2.10	2.50	90	180	
	Ultra Green	AlGaInP	574		2.20	2.50	70	120	

Absolute maximum ratings (Ta=25°C)

Parameter	E	UE	Y	G	UG	Unt
Forward Current I _F	25	30	25	30	30	mA
Power Dissipation P _d	60	65	60	65	75	mW
Reverse Voltage V _R	5	5	5	5	5	V
Peak Forward Current I _{PF} (Duty 1/10 @1KHZ)	150	150	150	150	150	mA
Operation Temperature T _{OPR}	-40 to +80					°C
Storage Temperature T _{STG}	-40 to +85					°C
Lead Soldering Temperature T _{SOL}	Max.260±5°C for 3 sec Max. (1.6mm from the base of the epoxy bulb)					°C

Cylindrical , bi-color LED lamp

BL-L345

Package configuration & Internal circuit diagram

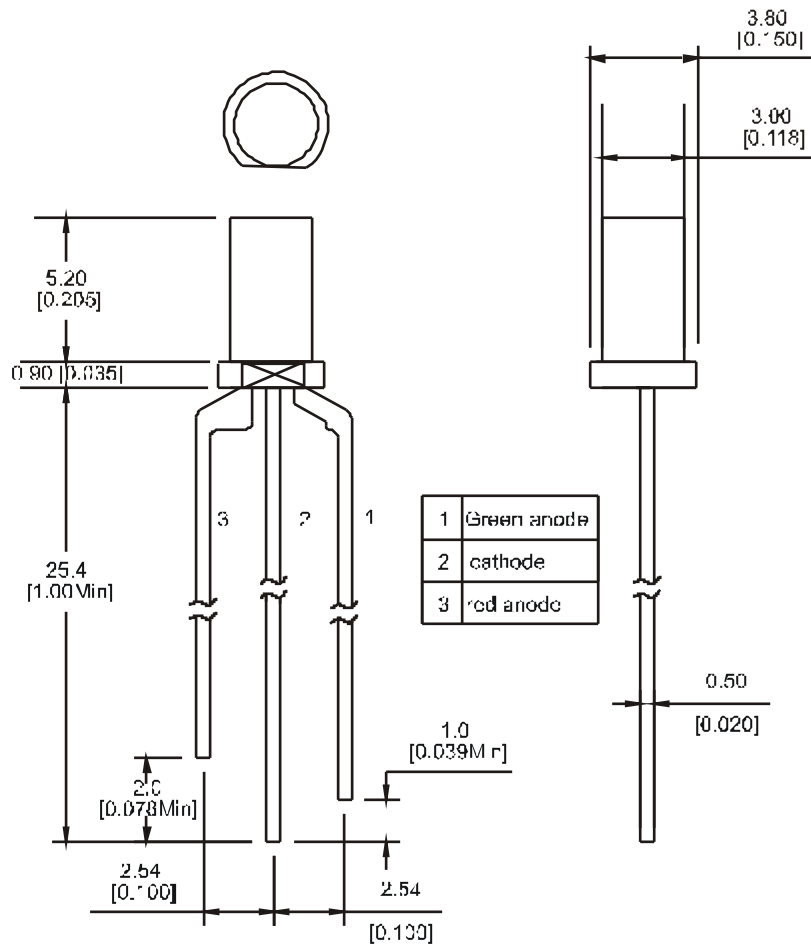

Notes:

1. All dimensions are in millimeters (inches)
2. Tolerance is $\pm 0.25(0.01)$ unless otherwise noted.
3. Specifications are subject to change without notice.

Cylindrical , bi-color LED lamp

BL-L345

Typical electrical-optical characteristics curves:

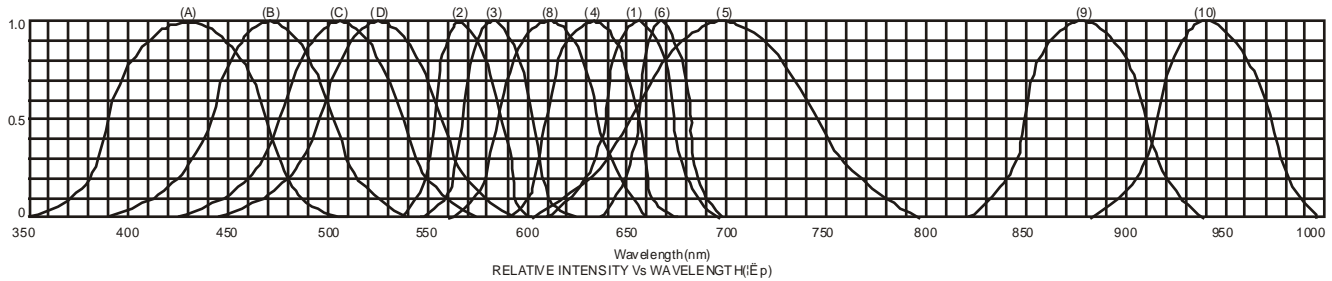

- (1) - GaAsP/GaAs 655nm/Red
- (2) - GaP 570nm/Yellow Green
- (3) - GaAsP/GaP 585nm/Yellow
- (4) - GaAsP/GaP 635nm/Orange & Hi-Eff Red
- (5) - GaP 700nm/Bright Red
- (6) - GaAlAs/GaAs 660nm/Super Red
- (8) - GaAsP/GaP 610nm/Super Red
- (9) - GaAlAs 880nm
- (10) - GaAs/GaAs & GaAlAs/GaAs 940nm
- (A) - GaN/SiC 430nm/Blue
- (B) - InGaN/SiC 470nm/Blue
- (C) - InGaN/SiC 505nm/Ultra Green
- (D) - InGaAlSiC 525nm/Ultra Green

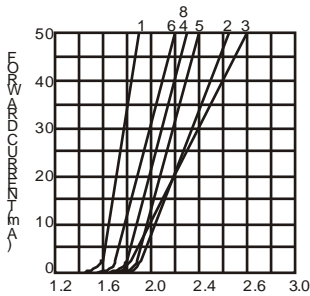

FORWARD VOLTAGE (Vf)
FORWARD CURRENT VS.
FORWARD VOLTAGE

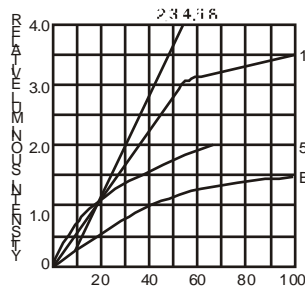

FORWARD CURRENT (mA)
RELATIVE LUMINOUS
INTENSITY VS. FORWARD
CURRENT

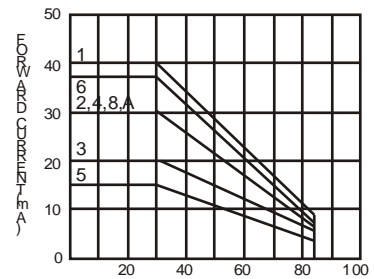

AMBIENT TEMPERATURE Ta (°C)
FORWARD CURRENT VS. AMBIENT
TEMPERATURE



AMBIENT TEMPERATURE Ta (°C)

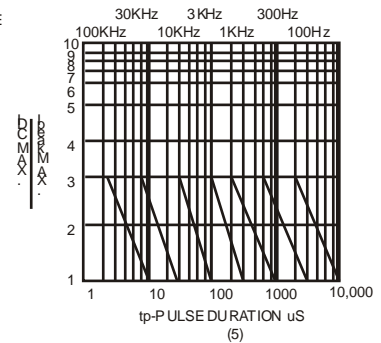
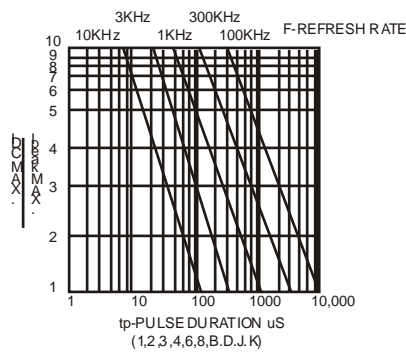

NOTE: 25 free air temperature unless otherwise specified

Cylindrical , bi-color LED lamp

BL-L345

Packing and weighting

