

## Cylindrical, Inverted Cone LED lamp

BL-L334

### Features:

- Ø 3.0mm Cylindrical, Inverted Cone LED lamp
- Ø Ultra brightness.
- Ø Choice of various viewing angles.
- Ø Diffused, Transparent and Water clear lens are available.
- Ø IC compatible /Low current capability.
- Ø RoHs Compliance



### Electrical-optical characteristics: (Ta=25°C) (Test Condition: IF=20mA)

Part Number	Chip			Lens Type	Forward Voltage(VF) Unit:V		Luminous Intensity (lv) Unit:mcd		Viewing Angle 2θ/2 (deg)
	Emitted Color	Material	λ <sub>p</sub> (nm)		Typ	Max	Min.	Typ.	
					BL-L334SRC	Hi Red	AlGaAs,SH	660	
BL-L334LRC	Super Red	AlGaAs,DH	660	1.85	2.20	60	120		
BL-L334URC	Ultra Red	AlGaAs,DDH	660	1.95	2.20	120	300		
BL-L334UEC	Ultra Orange	AlGaInP	630	2.10	2.50	150	400		
BL-L334UYC	Ultra Yellow	AlGaInP	590	2.10	2.50	150	400		
BL-L334UGC	Ultra Green	AlGaInP	574	2.20	2.50	30	100		
BL-L334PGC	Ultra Pure Green	InGaN	525	3.80	4.50	300	1000		
BL-L334BGC	Ultra Bluish Green	InGaN	505	3.80	4.50	220	800		
BL-L334BC	Blue	InGaN	430	3.80	4.50	400	800		
BL-L334UBC	Ultra Blue	InGaN	470	2.70	4.20	500	1000		
BL-L334VC	UV	InGaN	405	3.80	4.50	30	100		
BL-L334UWC	Ultra White	InGaN	/	2.70	4.20	250	1200		

### Absolute maximum ratings (Ta=25°C)

Parameter	SR	LR	UR	UE	UY	UG	PG	BG	B	UB	UV	W	Unit
Forward Current I <sub>F</sub>	25	25	25	30	30	30	30	30	30	30	30	30	mA
Power Dissipation P <sub>d</sub>	60	60	60	65	65	75	110	110	120	120	120	120	mW
Reverse Voltage V <sub>R</sub>	5	5	5	5	5	5	5	5	5	5	5	5	V
Peak Forward Current I <sub>PF</sub> (Duty 1/10 @1KHZ)	150	150	150	150	150	150	150	100	100	100	100	100	mA
Operation Temperature T <sub>OPR</sub>	-40 to +80												°C
Storage Temperature T <sub>STG</sub>	-40 to +85												°C
Lead Soldering Temperature TSOL	Max.260±5°C for 3 sec Max. (1.6mm from the base of the epoxy bulb)												°C

# Cylindrical, Inverted Cone LED lamp

BL-L334

## Package configuration & Internal circuit diagram

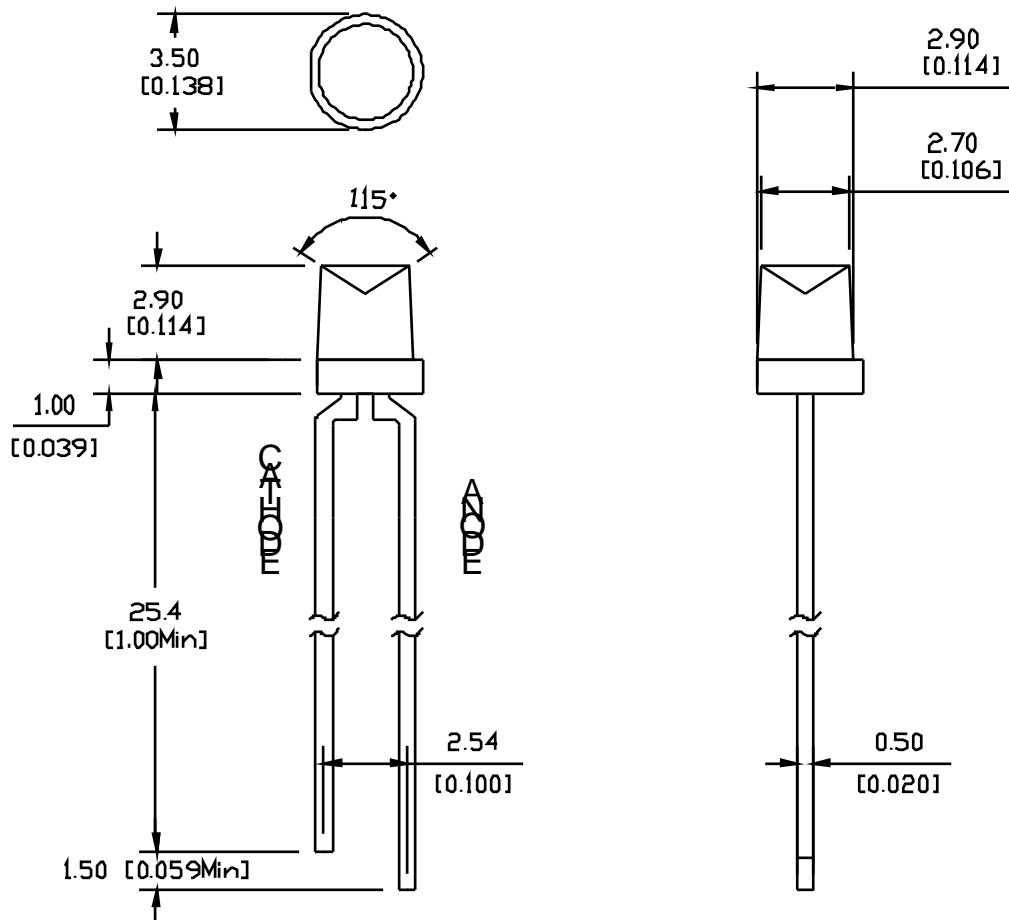

### Notes:

1. All dimensions are in millimeters (inches)
2. Tolerance is  $\pm 0.25$  (0.01") unless otherwise noted.
3. Specifications are subject to change without notice.

# Cylindrical, Inverted Cone LED lamp

BL-L334

## Typical electrical-optical characteristics curves:

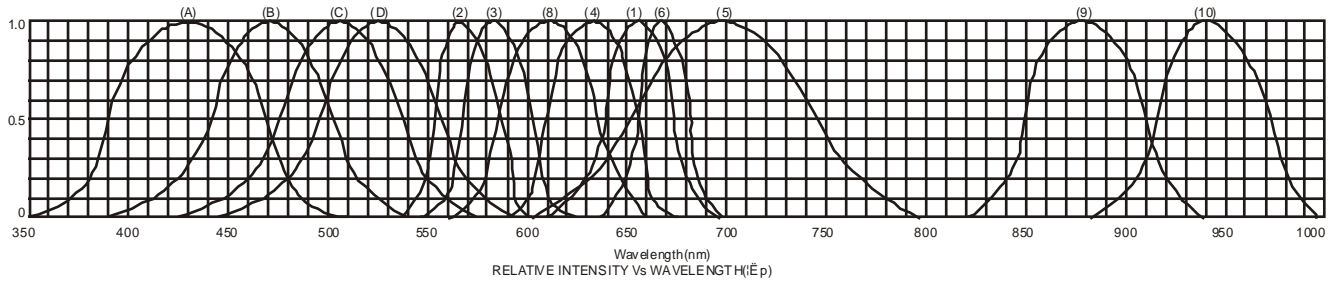

- (1) - GaAsP/GaAs 655nm/Red
- (2) - GaP 570nm/Yellow Green
- (3) - GaAsP/GaP 585nm/Yellow
- (4) - GaAsP/GaP 635nm/Orange & Hi-Eff Red
- (5) - GaP 700nm/Bright Red
- (6) - GaAlAs/GaAs 660nm/Super Red
- (8) - GaAsP/GaP 610nm/Super Red
- (9) - GaAlAs 880nm
- (10) - GaAs/GaAs & GaAlAs/GaAs 940nm
- (A) - GaN/SiC 430nm/Blue
- (B) - InGaN/SiC 470nm/Blue
- (C) - InGaN/SiC 505nm/Ultra Green
- (D) - InGaAlSiC 525nm/Ultra Green

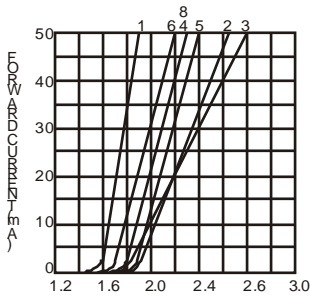

FORWARD VOLTAGE (Vf)  
FORWARD CURRENT VS.  
FORWARD VOLTAGE

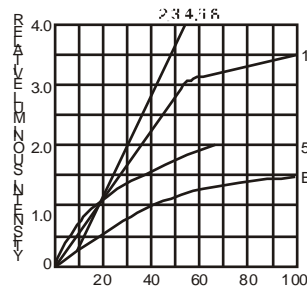

FORWARD CURRENT (mA)  
RELATIVE LUMINOUS  
INTENSITY VS. FORWARD  
CURRENT

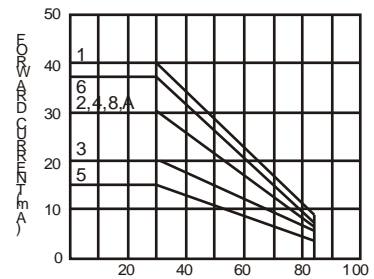

AMBIENT TEMPERATURE Ta ( °C )  
FORWARD CURRENT VS. AMBIENT  
TEMPERATURE

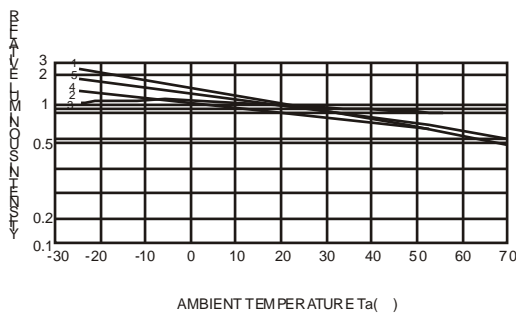

AMBIENT TEMPERATURE Ta ( °C )

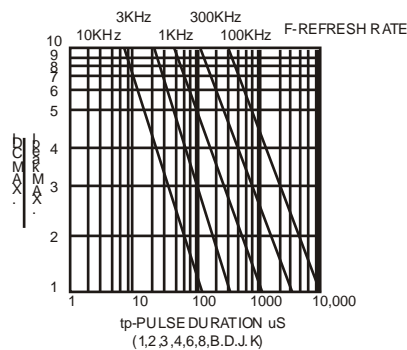

tp-PULSE DURATION  $\mu$ s  
(1,2,3,4,6,8,B,D,J,K)

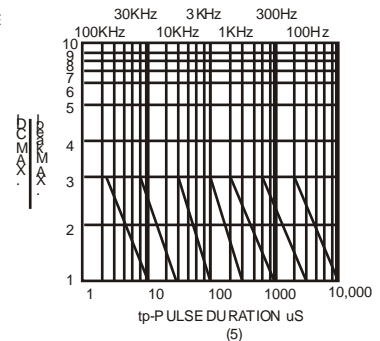

tp-PULSE DURATION  $\mu$ s  
(5)

NOTE:25 free air temperature unless otherwise specified

Cylindrical, Inverted Cone LED lamp

BL-L334

Packing and weighting

