

Round Type, Blinking LED lamp

BL-L513XX-B

Features:

- Ø 5mm Round Blinking (flash) LED Lamps
- Ø Ultra brightness.
- Ø Choice of various viewing angles.
- Ø Diffused, Transparent and Water clear lens are available.
- Ø IC compatible /Low current capability.
- Ø RoHs Compliance



Electrical-optical characteristics: (Ta=25°C) (Test Condition: IF=50mA)

Part Number	Chip			Lens Type	Pulse Rate(Hz) VDD=5V (Hz)			Luminous Intensity (Iv) Unit:mcd		Viewing Angle 2θ/2 (deg)
	Emitted Color	Material	λp (nm)		Min	Typ	Max	Min.	Typ.	
BL-L513SRC-B	Hi Red	AlGaAs,SH	660	Water Clear	2.0	2.4	2.8	50	250	20
BL-L513LRC-B	Super Red	AlGaAs,DH	660		2.0	2.4	2.8	250	600	
BL-L513URC-B	Ultra Red	AlGaAs,DDH	660		2.0	2.4	2.8	600	1000	
BL-L513UEC-B	Ultra Orange	AlGaInP	630		2.0	2.4	2.8	800	2000	
BL-L513UYC-B	Ultra Yellow	AlGaInP	590		2.0	2.4	2.8	1000	2200	
BL-L513UGC-B	Ultra Green	AlGaInP	574		2.0	2.4	2.8	300	700	
BL-L513PGC-B	Ultra Pure Green	InGaN	525		2.0	2.4	2.8	2000	5000	
BL-L513BGC-B	Ultra Bluish Green	InGaN	505		2.0	2.4	2.8	1800	4000	
BL-L513UBC-B	Ultra Blue	InGaN	470		2.0	2.4	2.8	2000	5000	
BL-L513VC-B	UV	InGaN	405		2.0	2.4	2.8	80	150	
BL-L513UWC-B	Ultra White	InGaN	/		2.0	2.4	2.8	3000	10000	

Absolute maximum ratings (Ta=25°C)

Parameter	SR	LR	UR	UE	UY	UG	PG	BG	B	UB	UV	W	Unit
Forward Current I _F	25	25	25	30	30	30	30	30	30	30	30	30	mA
Power Dissipation P _d	60	60	60	65	65	75	110	110	120	120	120	120	mW
Reverse Voltage V _R	5	5	5	5	5	5	5	5	5	5	5	5	V
Peak Forward Current I _{PF} (Duty 1/10 @1KHZ)	150	150	150	150	150	150	150	100	100	100	100	100	mA
Operation Temperature T _{OPR}	-40 to +80												°C
Storage Temperature T _{STG}	-40 to +85												°C
Lead Soldering Temperature TSOL	Max.260±5°C for 3 sec Max. (1.6mm from the base of the epoxy bulb)												°C

Round Type, Blinking LED lamp

BL-L513XX-B

Package configuration & Internal circuit diagram

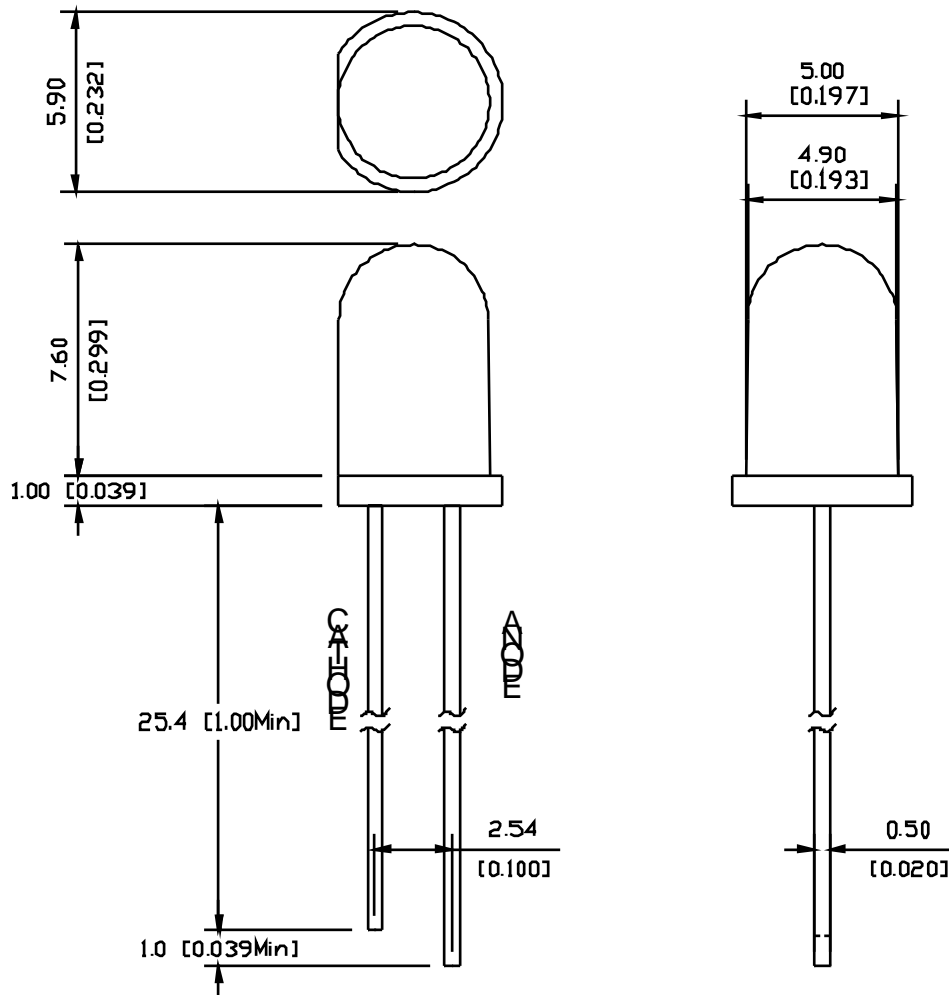

Notes:

1. All dimensions are in millimeters (inches)
2. Tolerance is $\pm 0.25(0.01)$ unless otherwise noted.
3. Specifications are subject to change without notice.

Round Type, Blinking LED lamp

BL-L513XX-B

Typical electrical-optical characteristics curves:

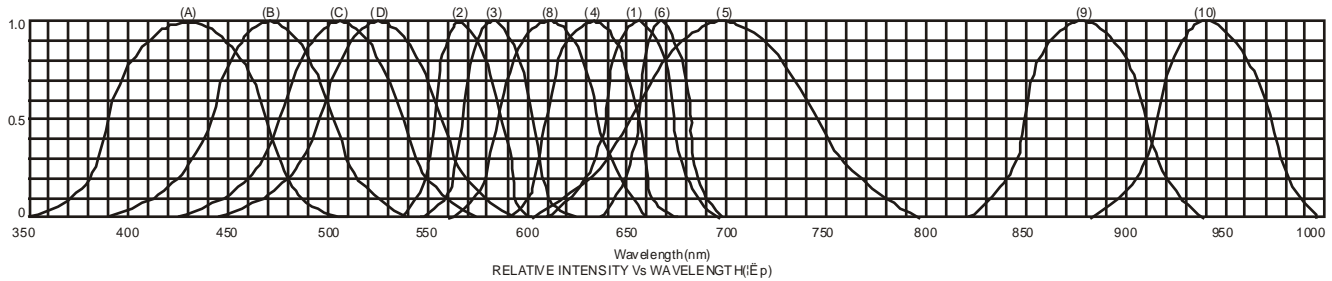

- (1) - GaAsP/GaAs 655nm/Red
- (2) - GaP 570nm/Yellow Green
- (3) - GaAsP/GaP 585nm/Yellow
- (4) - GaAsP/GaP 635nm/Orange & Hi-Eff Red
- (5) - GaP 700nm/Bright Red
- (6) - GaAlAs/GaAs 660nm/Super Red
- (8) - GaAsP/GaP 610nm/Super Red
- (9) - GaAlAs 880nm
- (10) - GaAs/GaAs & GaAlAs/GaAs 940nm
- (A) - GaN/SiC 430nm/Blue
- (B) - InGaN/SiC 470nm/Blue
- (C) - InGaN/SiC 505nm/Ultra Green
- (D) - InGaAlSiC 525nm/Ultra Green

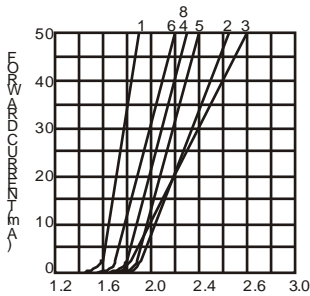

FORWARD VOLTAGE (Vf)
FORWARD CURRENT VS.
FORWARD VOLTAGE

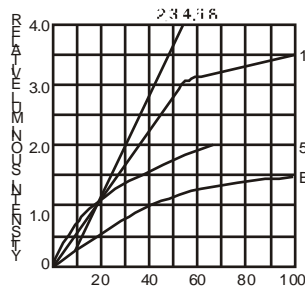

FORWARD CURRENT (mA)
RELATIVE LUMINOUS
INTENSITY VS. FORWARD
CURRENT

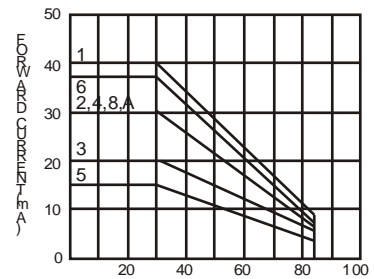

AMBIENT TEMPERATURE Ta ()
FORWARD CURRENT VS. AMBIENT
TEMPERATURE



AMBIENT TEMPERATURE Ta ()

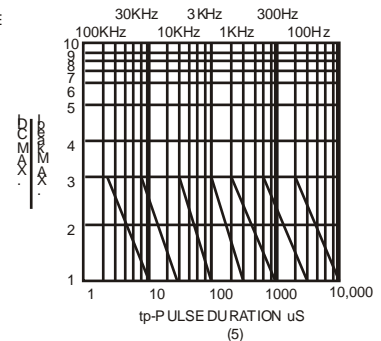
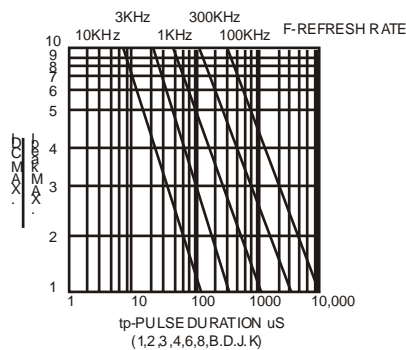

NOTE: 25 free air temperature unless otherwise specified

Round Type, Blinking LED lamp

BL-L513XX-B

Packing and weighting

