

LED LAMP CLUSTER

BL-CS28AR4G12

Features:

- Ø 28mm Square LED lamp cluster
- Ø High visibility
- Ø Emitting Color: red,green,blue
- Ø No of Built-in 5mm LED Lamps :
- Ø Ultra orange - 4pcs,green – 12pcs
- Ø Waterproof Package With Hood Suitable
- Ø For Outdoor and Indoor Information Boards



Selection Guide

Part No.	Description
BL-CS28AR4G12	28mm square Lamp cluster .4red ,12 green, square packed

Description:

-Color Code & Chip characteristics: (Test Condition: IF=20mA)

Part No.	Built-in Lamp Package	Built-in Lamp Part No. BL-	Chip		Lens Appearance	Electro-optical Data(At 20mA)			Viewing Angle 2:θ/2 (deg)
			Material/Emitted Color	Peak Wave Length λp (nm)		Vf (V)		Iv (mcd)	
						Typ	Max		
BL-CS28AR4G12	4x5x7mm 1.0" Lead Oval	L563UEC	AlGaInP/ Ultra Orange	630	Water clear	2.10	2.50	750	X-X 45 Y-Y 25
		L563UGC	AlGaInP/ Ultra Green	574	Water clear	2.20	2.50	600	

Notes:

1. θ/2 Is the angle from optical centerline where the luminous intensity is 1/2 the optical centerline value.

Absolute Maximum Rating (Each Lamp,Ta=25°C Derate above 25°C)

Characteristic	Symbol	Ultra Orang	Ultra Green	Unit
Spectral Line Half width	λ _{1/2}	17	30	nm
Pulse Forward Current	IFp	150	150	mA
DC Forward Current	IF	30	30	mA
Reverse Voltage	V _R	5	5	V
Power Dissipature	PD	65	75	mW
Operating Temperature	Topr	-40°C-80°C		
Storage Temperature	Tstg	-40°C-85°C		
Lead Soldering Temperature		Max.260±5°C for 3 sec Max. (1.6mm from the base of the epoxy bulb)		

LED LAMP CLUSTER

BL-CS28AR4G12

Package configuration & Internal circuit diagram:

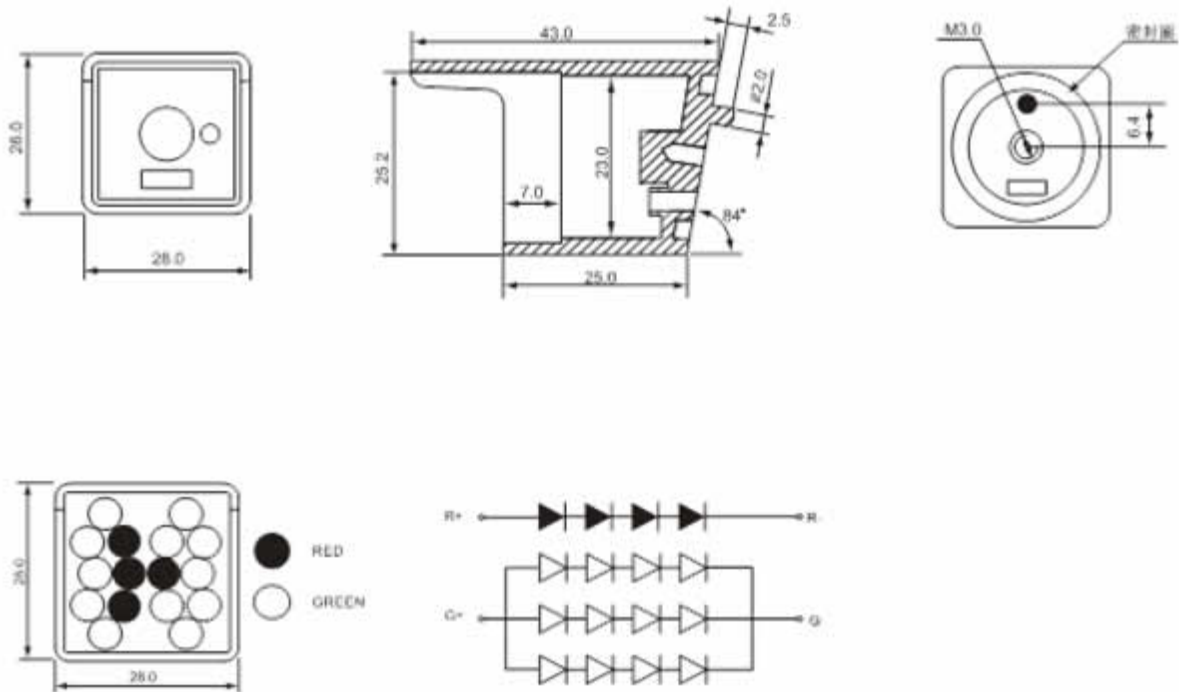

Notes:

- All dimensions are in millimeters (inches)
- Tolerance is $\pm 0.25(0.01)$ unless otherwise noted.
- Specifications are subject to change without notice.

LED LAMP CLUSTER

BL-CS28AR4G12

Typical electrical-optical characteristics curves:

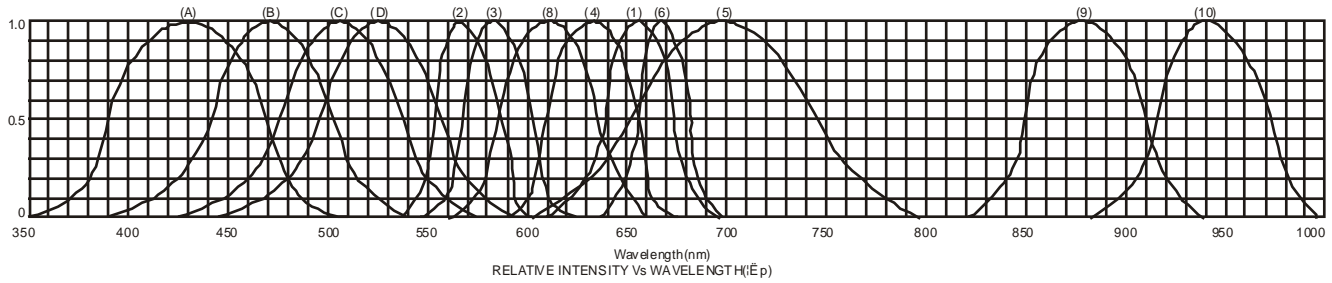

- (1) - GaAsP/GaAs 655nm/Red
- (2) - GaP 570nm/Yellow Green
- (3) - GaAsP/GaP 585nm/Yellow
- (4) - GaAsP/GaP 635nm/Orange & Hi-Eff Red
- (5) - GaP 700nm/Bright Red
- (6) - GaAlAs/GaAs 660nm/Super Red
- (8) - GaAsP/GaP 610nm/Super Red
- (9) - GaAlAs 880nm
- (10) - GaAs/GaAs & GaAlAs/GaAs 940nm
- (A) - GaN/SiC 430nm/Blue
- (B) - InGaN/SiC 470nm/Blue
- (C) - InGaN/SiC 505nm/Ultra Green
- (D) - InGaN/SiC 525nm/Ultra Green

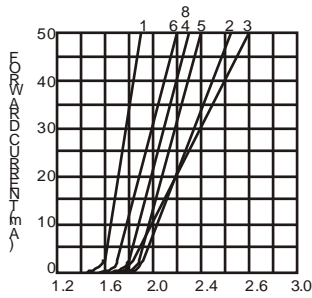

FORWARD VOLTAGE (Vf)
FORWARD CURRENT VS.
FORWARD VOLTAGE

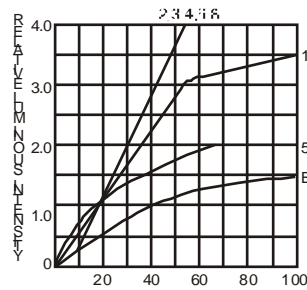

FORWARD CURRENT (mA)
RELATIVE LUMINOUS
INTENSITY VS. FORWARD
CURRENT

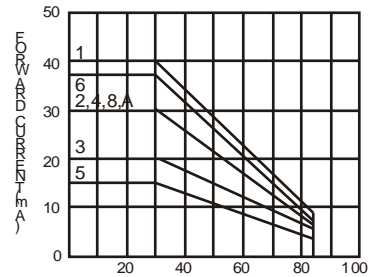

AMBIENT TEMPERATURE Ta(°C)
FORWARD CURRENT VS. AMBIENT
TEMPERATURE

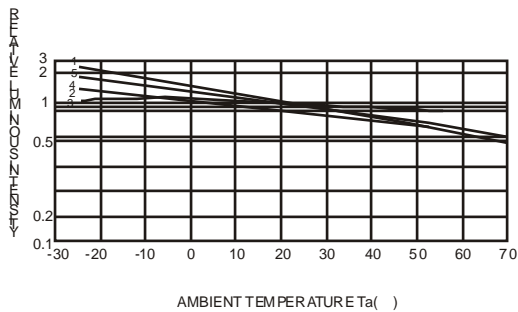

AMBIENT TEMPERATURE Ta(°C)

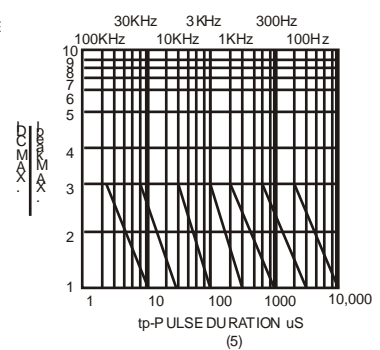
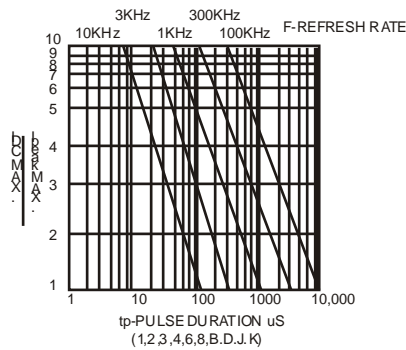

NOTE:25 free air temperature unless otherwise specified

LED LAMP CLUSTER

BL-CS28AR4G12

Packing and weighting

